



**Judgebook  
Installation  
2026**

Preface .....	2
3.0 Installation .....	2
Presentation to the public .....	3
Bonus Presentation to the public .....	3
Cleanliness .....	4
System documentation .....	4
Explanation of system to the judges .....	5
Main Fuse(s) present .....	5
Are all wires to the components fused.....	5
Fuse of appropriate value .....	6
Interior wires invisible.....	8
Wires properly terminated.....	9
Wire terminations protected.....	10
Wires protected from damage .....	11
All components securely mounted.....	11
Protection of speakers .....	12
Does the vehicle allow a normal use? .....	13
First Optic impression .....	15
Design of interior.....	15
Design of trunk.....	15
Overall design of car.....	15
Craftsmanship.....	16
Bonus points .....	17



## Welcome to the European Mobile Media Association

### Preface

This manual is designed to describe the exact procedure, used for judging the install portion of a vehicles audio system, according to EMMA Rules & regulations and will be continuously updated.

### 3.0 Installation

The installation process used to judge cars is the same regardless of the competition level. The difference between the competitions levels are which items from this judge book you are assessed on. For example, the criteria for 'Cleanliness' is the same for E (Entry Level) all the way through to X (Expert Level). Therefore if a Competitor earns 6 points for Cleanliness at E level, the competitor would also get 6 points at X level.

The install items that are judge for each level of competition are shown in the matrix below.

<b>Matrix Installation</b>						
	<b>E</b>	<b>S</b>	<b>M</b>	<b>X</b>	<b>X Unl</b>	
Max. points	<b>69</b>	<b>115</b>	<b>161</b>	<b>231</b>	<b>325</b>	
Presentation to the public	10	10	10	10	10	
Bonus Presentation to the public			5	5	5	
Cleanliness	6	6	6	6	6	
System / Wiring Diagram	4	4				
System documentation			10	10	10	
Explanation of system to the judges			5	10	10	
Main fuse(s) present y/n	10	10	10	10	10	
Are all wires to the components fused?		15	15	15	15	
Is the fuse value appropriate to the wire size?		20	20	20	20	
Any interior wires visible?		5	5	5	5	
Wires properly terminated?			5	5	5	
Wire terminations protected y/n			10	10	10	
Wires protected from damage y/n			5	5	5	
Are all components securely mounted?	24	24	24	24	24	
Protection of speakers	5	5	5	5		
Does the vehicle allow a normal use?		6	6	6		
First Optic impression	10	10	10	10	10	
Craftsmanship			10	50	50	
design of interior				5	10	
design of trunk				5	10	
Overall design of vehicle					10	
Bonus points				15	100	

## Presentation to the public

The competitor should:

- 'Show off' their vehicle & installation to the public during the event time/s.
- Allow spectators to listen to the system.
- Please note: This will be checked several times a day
- If it is an outdoor event and the weather is poor, the car can be closed but system details should still be visible. (E.g. displayed on the dashboard etc.)
- Exception: at the event active judges / back office staff's cars can remain closed due to safety reasons.

**Points will be deducted as appropriate, i.e. commensurate to the time the car is not being shown to the public.**

## Bonus Presentation to the public

Additional points are available when the competitor is actively promoting their car / Installation / Presentation during the event time.

Judges should look for the following

- Display to promote the system components.
- Information available to illustrate the work put in to the installation.
- Exception: at the event active judges / back office staff's cars can remain closed due to safety reason.

**Note: This will be checked several times a day**

The scoring criteria are as follows.

- 1 Point: Some documentation is available and on display.
- 2 Points: All documentation is available and on display.
- 3 Points: All documentation is available, on display and is to a high standard.
- 4 Points: All documentation is available, on display and the competitor is available to interact with the spectators whenever needed.
- 5 Points: All documentation is available, on display, is to a high standard and the competitor is available to interact with the spectators whenever needed.

**Points can also be deducted appropriate, should there be times during the event that the car is not being shown to the public.**



## Cleanliness

Cars should be clean and presentable, the Car exterior should be "car-wash-clean" and interior should be vacuumed (not perfect but reasonably clean). The criteria you should check against are as follows:

- Car Wash clean y/n
- Passenger compartment clean y/n
- Dedicated components (e.g. Batteries or fuse holders etc) of the system installed in the engine component and trunk clean y/n
- No items i.e.: clothing, tools, and food wrappers on display?

**Deduct 2 points per not cleaned area, Minimum 0 Points**

## System documentation

This is not to be judged like a Presentation, nor is this to judge the craftsmanship. It is possible that a bad installation can be perfectly documented and score full points for System Documentation. Should the installation allow for all the components and wire connections to be visible by the judge, the only System Documentation items needed are as follows.

- Signal Flow-chart (E.g. Signal Source, DSP (if installed), then which amplifiers to what speakers etc.
- Wiring Diagram including cable size and Fuse Diagram including fuse sizes.

The system documentation is required when the competitor has changed something from OEM. Therefore if OEM equipment is used, this can be excluded from the documentation requirements to score full points.

All components not accessible or hidden from view should be explained in the documentation in order to claim full points for that section.

Examples of items the judges should look for:

- Black boxes
- Crossovers (passive and/or active)
- Speakers behind door panels or dashboard grills
- Additional batteries
- Head unit DC/DC Converters
- Head unit Black Boxes

All wires to components (and their terminations or fixings) not accessible or hidden from view should be explained in the documentation.

Examples of items the judges should look for:

- Behind source unit
- Black boxes
- Crossovers (active and/or passive)
- Behind/under covers, racks, carpets etc.
- Power / Ground wires
- Speaker wires
- Signal-cables (including cables to multi-media-screens, remote controls, etc.!!!)
- Control-cables (bus-cable to processors etc.)
- Connections to additional batteries

### **Explanation of system to the judges**

The Competitor (or their designate) is allowed up to 7 minutes to explain the audio system. X Unlimited is afforded a maximum of 15 minutes.

The Competitor is NOT required to:

- Go through the documentation
- Comment on brands chosen

They should focus on how & why the installation was built a certain way and also the final result.

**Note:** No movies are allowed.

**1 point will be deducted per 30sec. Over time**

### **Main Fuse(s) present**

Check if a 'Main Fuse' has been installed onto the (or each) main power wire within 40cm from any positive battery post and/or before passing any metal panel. This should include all wires from the battery post.

Any permanent wires installed into the car for battery charging even if they are not in use shall also be judged for fusing.

**NOTE:** If more than one battery is installed, each battery needs a main fuse from its battery post. If batteries are joined to each other within 40cm of each battery post, it will be considered as one big battery. If multiple batteries are connected to a busbar all wires connected to the busbar should have main fuses within 40 cm from the closest positive battery post (not 40 cm from the busbar, battery post is in the battery not in the busbar!). At this point the fuse rating is not checked.

**If any main fuse is not present, 0 points will be awarded**

### **Are all wires to the components fused**

Check, if a fuse is installed on the positive power wire for every component belonging to the audio/multi-media system.

All fuses connected to the components must be visible within three minutes (for all fuses in total, not three minutes for every fuse!!!). The judge should check to ensure the following components are fused:

- Head Unit
- Other devices
- Amplifiers

Power diagram is necessary for judging.

**Deduct 2 points per component that is NOT fused or whose fuse is not visible within the 3 minutes. Minimum 0 Points**

**NOTE:** The fuse rating is not checked at this point.

### Fuse of appropriate value

Check every fuse that belongs to the audio system is of an appropriate size for the wire it is protecting (according to the VW75212 - Dimensionierung von Leitungen und Sicherungen im Kraftfahrzeug):

When checking the fuse rating this should be appropriate for the smallest size cable in the circuit used to power the component, Positive or Negative, according to the table below:

**NOTE:** Fuse rating is based on mm<sup>2</sup> the AWG sizes are just for reference.

Fuse Size Matrix			
	Cable size	AWG	Fuse Rating
	0,5mm <sup>2</sup>	20	10 Ampere
	1,0mm <sup>2</sup>	17	15 Ampere
	1,5mm <sup>2</sup>	15	20 Ampere
	2,5mm <sup>2</sup>	13	20 Ampere
	4,0mm <sup>2</sup>	11	30 Ampere
	6,0mm <sup>2</sup>	9	50 Ampere
	10mm <sup>2</sup>	7	60 Ampere
	16mm <sup>2</sup>	5	100 Ampere
	25mm <sup>2</sup>	4	125 Ampere
	35mm <sup>2</sup>	2	175 Ampere
	50mm <sup>2</sup>	0	250 Ampere
	70mm <sup>2</sup>	2/0	300 Ampere

Alternatively, wire sizes and fuse ratings can be calculated with the formulas in the “**How to calculate wire sizes**” section below. If the competitor chooses to use a fuse rating for a cable not shown in the standard table above, the calculations must be documented and provided to the judges for checking.

This rule applies to all electrical conductors in the power system, power distribution blocks, busbars etc. On multiple battery systems pay close attention to all batteries / fuses feeding current to any distribution block. There can be power sources connected on both sides of a short circuit and the conductor must withstand the combined current of all sources feeding the short circuit.

**Deduct 2 points per incorrect or NOT fused component, minimum 0 Points**

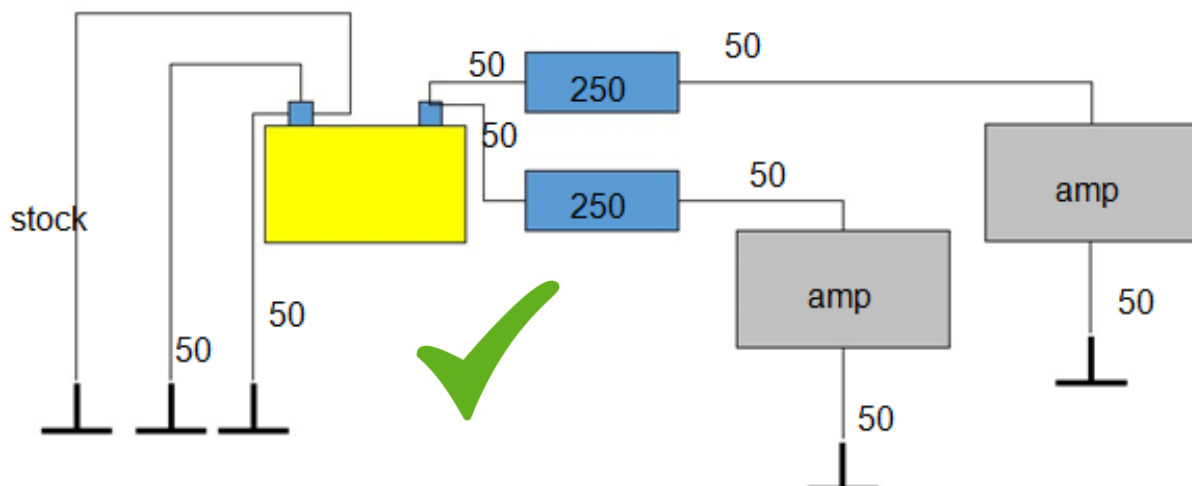

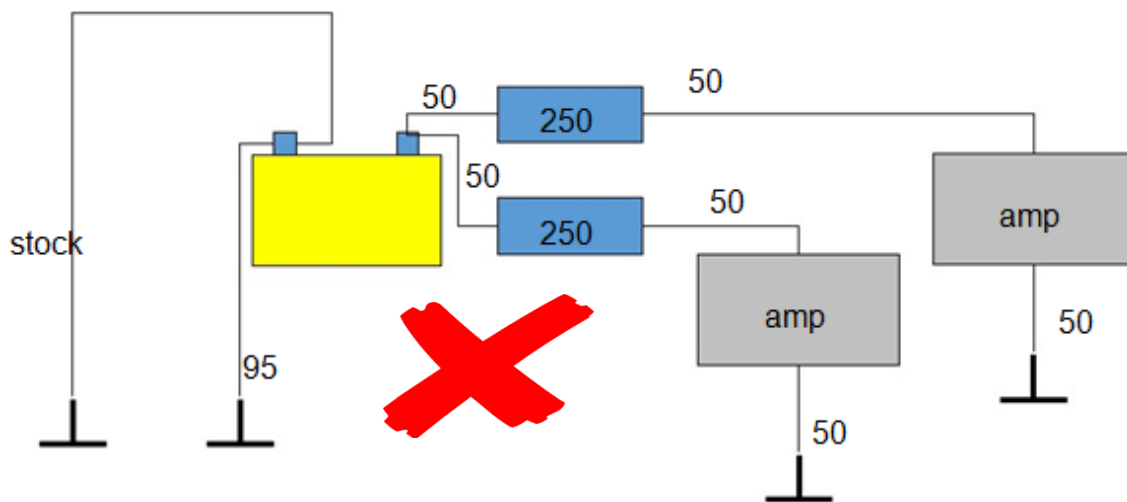

**NOTE FOR COMPETITORS:  
How to calculate wire sizes**

How to check, if the wire size is appropriate (e.g. IF the OEM ground cable is not upgraded):

Calculate wire size:

$$A = ( I \times 0,0175 \times L \times 2 ) / (fk \times U)$$

A= wire size in sqmm

I = max amperage

0,0175 specific resistance of OFC copper in Ohm x mm<sup>2</sup> / m (for CCAW the factor must be 0,0283)

L = cable length (of entire circuit including positive & ground wire) in m

fk = factor of loss, E.g.: 2%, is 0,02

U = voltage = 12 V (In ESPL Expert the system's nominal voltage)

Factor of loss should be no higher than 2%

If the calculated wire size is not available, step up to next available wire size

Important info:

In case CCAW-cable is used, there must be 1,6x more sqmm or it can handle 0,625x the current of OFC-cable. It is assumed that the OEM-ground wire is OFC.

Competitor/installer needs to calculate the appropriate wire sizes for his installation and document it to the judges.

If the calculation is not available for the judges, the published table for wire sizes and fuse values will be used for judging

Formula changed to I do determine capability of a given ofc cable:

$$I = ( A \times fk \times U ) / ( 0,0175 \times L \times 2 )$$

**Guidance for cars equipped with Intelligent Battery Sensor (IBS) / Smart Charge Alternator / Stop Start Technology.**

When a vehicle has a sensor on the OEM Chassis ground wire to the battery, all current must pass through the sensor to maintain a fully functioning Intelligent Battery System. E.g. "Stop/start" technology.

If the car's OEM ground cable is not upgraded the biggest allowed size for the main fuse (or combined size of multiple main fuses) is 100 A unless the competitor provides a calculation with the enclosed formula using car's OEM ground cable size.

It is up to the competitor to design and install the audio system to the current rulebook.

EMMA is aware of two ways to maintain the function of the (IBS) sensor and comply with the rulebook, (there may be more):

1. Fuse the main power cable for the audio system to the maximum value the OEM Ground wire would allow (using the calculations above).
2. Add an extra (appropriate size) ground wire from the IBS sensor to the chassis or audio system.

If in doubt, please consult your vehicle manufacturer for further advice.

**Interior wires invisible**

Check if any wires of the audio system installation are visible. This is judged from 'the drivers seating position'. This should be done with the doors closed and open.

- Any cables behind the B pillars are not judged.
- Cables under the dash should not be judged unless these are visible whilst sitting on the drivers' seat.

**NOTE:** Mobile devices such as smartphones that are connected by a cable to a connector on the HU/Car AND the device itself will be operated at the head unit, the mobile device is treated as a storage device and no attention will be given to this cable.

If the mobile device is used to operate the system (e.g. to change the track would be enough), there should be no wire visible (however the connector being visible is ok)!

**Hint:** This could also mean that the device must be fixed / installed - because it streams...

**Deduct 2 points for any visible system wire, Minimum 0 Points**



ww





### Wires properly terminated

The judge should check all wires are properly terminated - either by physical inspection or by photo log.

This should include the following:

- Power cable, (Positive and Negative)
- Signal cables
- Speaker cables
- Control or data cables

A correctly terminated wire should not have any internal strands of the wire on show.

**Deduct 1 point per not properly terminated wire, Minimum 0 Points**

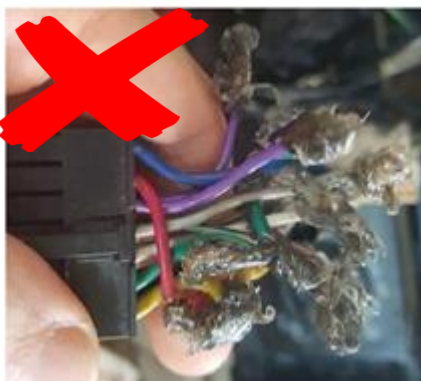
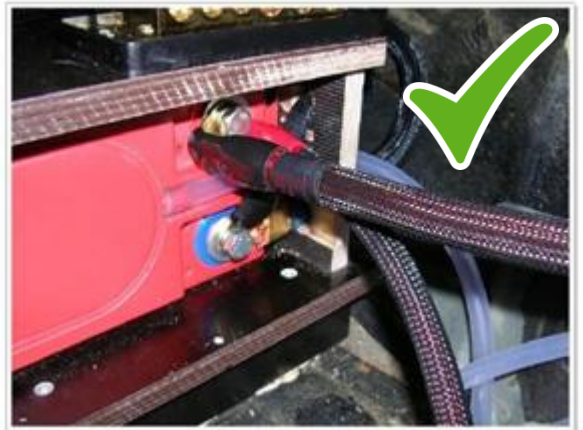



### Wire terminations protected

Check if the wire terminations are installed in such a way that short circuits are avoided and terminals are covered by a non-conductive material when the vehicles is in driving condition (all panels/covers on etc.) and appropriate measures are taken if wire terminations are exposed to moisture (e.g.in the doors) - either by physical inspection or by photo log in the system documentation.

The judges will check by physical inspection and the documentation. All relevant terminations should be accessible or shown in the documentation. If the positive battery post and any other termination of the cabling can be touched (watch out: fingers are flexible!) or only one unprotected cable termination is detected physically or in the photo documentation or missing in the documentation, the score will be deducted by 1 point. OEM wiring is excluded from this judging.

- Non-conductive cover panels can be used as protection as long as they are present at the time of judging.
- The cars bonnet is NOT classed as protection.
- Non-conductive battery boxes can be used as protection (including OEM).

**Deduct 1 point per not properly protected wire, Minimum 0 Points**

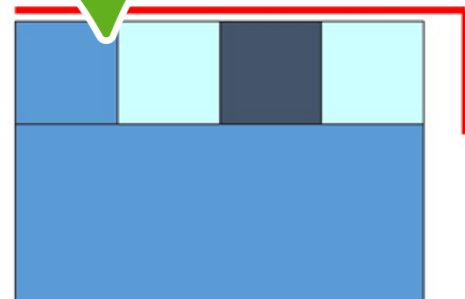
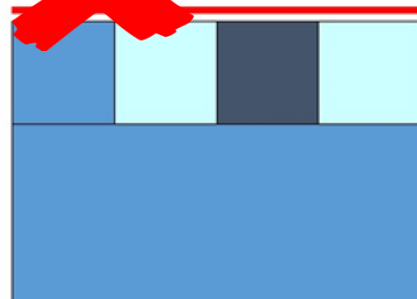
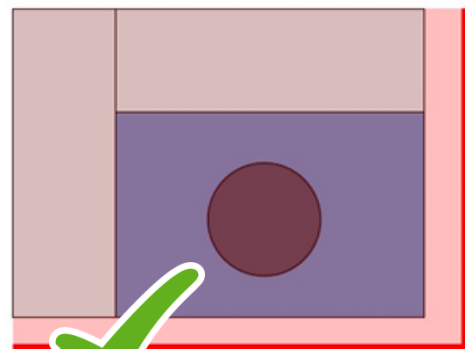
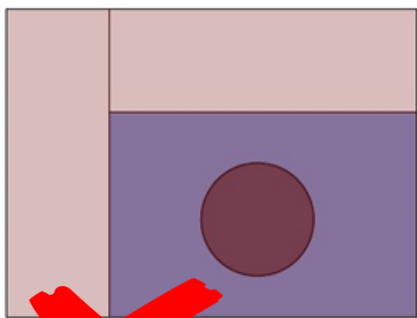

**Wires protected from damage**

Wires that pass through metal (e.g. from engine compartment to interior) should be protected by a grommets, rubbers or similar. For wires, that are mechanically stressed (e.g. into the door) or that are close to moving parts (e.g. engine-belts) protective sleeving should be used if not installed in the OEM's cable trays.

**Deduct 1 point per not properly protected wire, Minimum 0 Points.**



**All components securely mounted**

Check all components by physical inspection to ensure they are fixed. Each component (shown below) should be checked to ensure they are secure. The security of the component should be proportionate with its size and weight. An 18" sub will need more securing than a tweeter would.

The judges should look for:

- Head Unit
- Other devices
- Amplifiers
- Speakers

**NOTE:** If any of the above items are not installed then no deduction will take place

**Deduct 2 points per not fixed component, minimum 0 Points**



## Protection of speakers

A speaker which is installed completely under the window line (outer frame diameter of speaker) needs protection. Speaker protection shall be defined as not flexible.

Check whether the affected speakers in the front interior compartments are protected from physical damage.

- Hidden Speakers like those mounted under the dashboard do not need any protection when they cannot be reached by the foot of the driver or passenger.
- You should not be able to touch the membrane with a cylindrical object with a diameter of 3 cm.
- There should be at least one protective element per speaker.
- A Phase plug cannot be classed as a protective element.
- The 3 cm diameter cylindrical object should be used at 90 degrees angle to the speaker face.
- Only speakers installed in the following location should be checked.
  - Front door cards
  - Lower dash panels
  - Under the dash
  - Front legroom areas

**NOTE:** A coax speaker is considered as a single speaker.

**Deduct 2 points for any speaker not protected, Minimum 0 Points.**

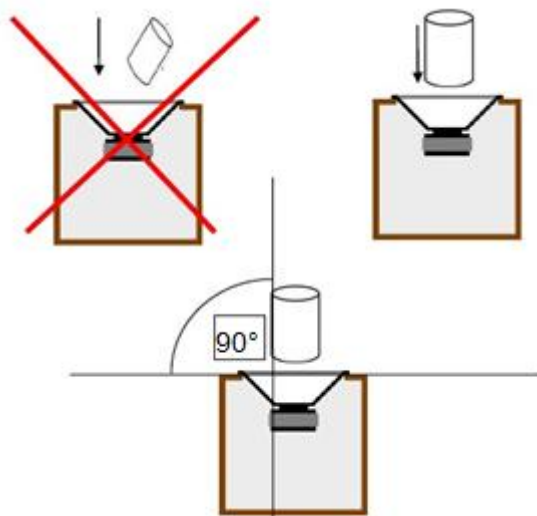

**Does the vehicle allow a normal use?**

EMMA is allowing modifications to the vehicles interior (except in OEM) to install audio components. The driver/ passenger should be able to sit comfortably and be able to operate the controls of the car without obstruction (look for sub/speakers up front or too high raised floor).

As the OEM designers have given the most safety and comfort in the limited available space of the passenger cabin, EMMA will use the OEM surfaces as references. This means that the driver's foot room must not be changed from OEM within the measurement limits on next page.

The passenger foot room must not be smaller than the OEM foot room on the driver side between seat and pedals.

Judging will be done in the regular driving position of the vehicles operator.

The Judge should check that the space deemed necessary, to correctly operate the car, by the manufacturer has not been encroached upon and that this same amount of space is available for the front seat passenger.

When checking this space the two front seats should be parallel so as to ensure the same space is available. To ensure the same space is available you should check the height width and depth as illustrated below.



There are three things to check for height.

1. The height from the floor to the top of the seat
2. The height from the floor to the top of the uppermost pedal
3. An unrestricted line should be able to be drawn between both of vertical lines.

**Note:** If the floor of the passenger side has been raised (to a MAX of 4 CM) then these heights need to be maintained.

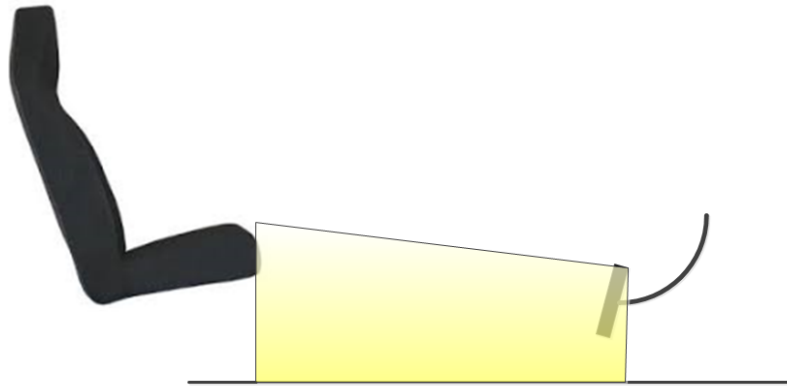

When checking the width you should ensure the following:

- Width from left most to right most peddle is maintained.
- When checking the left and right most peddle these should include all of the following (if fitted)
  - Accelerator
  - Brake
  - Clutch
- The width of the seat is maintained
- An unrestricted line should be able to be drawn between both of width lines as below.

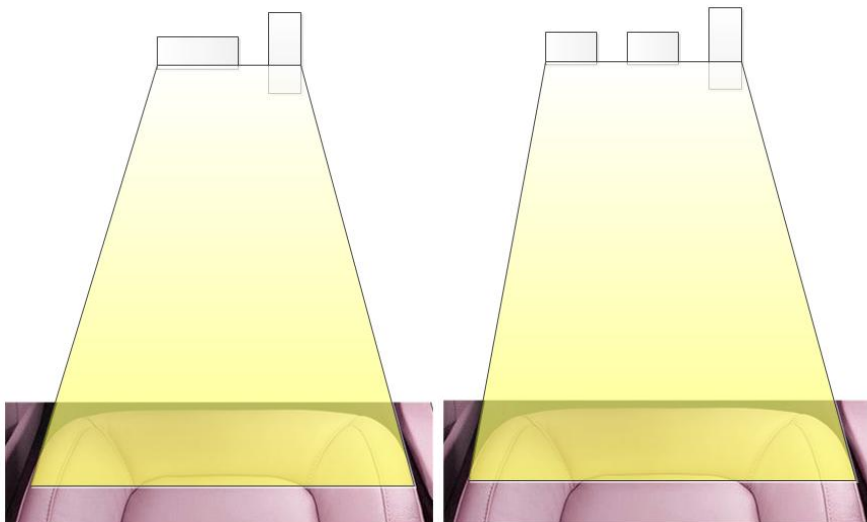

**Note:** The width at the pedals could move one way or the other but this width must be maintained and a straight line from the side of the seat to each side of the foot well needs to be maintained.

**Deduct 2 points per element that is restricting the OEM standards Maximum -6 Points**

## First Optic impression

The Judge will check all components to ensure they create the impression of "a finished installation" and not an "under construction" impression.

The judge will need to look at the following items:

- Head Unit
- Other devices
- Amplifiers
- Speakers / Speaker enclosures
- Cover and trim panels.

**Deduct 1 point per "under construction" component, Minimum 0 Points**

## Design of interior

The judge should check that all components installed to the interior follow a clear design idea. The judging is not a question of your personal taste. It's a question of concept and a consistent theme.

**Deduct 1 point per element not following the design idea, Minimum 0 Points**

## Design of trunk

The judge should check that all components installed to the trunk follow a clear design idea. The judging is not a question of your personal taste. It's a question of concept and a consistent theme.

**Deduct 1 point per element not following the design idea, Minimum 0 Points**

## Overall design of car

To score full points, the car itself and the components installed in it must show a design theme that was followed throughout the car; inside, outside and to the trunk compartment. It should be immediately clear that the car was designed as a project from beginning to end, with a clear statement to the judges and the viewers.

The design theme is not important; but the competitor should be aware that an original looking car will not be able to score any points on the areas where no effort for design was taken.

**Deduct 1 point per element not following the design idea, Minimum 0 Points**



## Craftsmanship

Craftsmanship evaluates the effort and quality of execution of the installation work performed. Judges should assess how carefully and professionally the installation work has been carried out and how much effort has been invested beyond the minimum necessary to install the component correctly.

Craftsmanship reflects the quality of the work performed, not the value or type of materials used. Expensive materials alone do not increase the score.

Check wire-routing, terminations, installation of components, installation of panels, surface finishes, equal gaps, etc. for the following 5 categories:

- Wiring
- Head Unit (Operator Panel, Display)
- Amplifiers
- Speakers
- Other Components

Judges should consider aspects such as:

- Fit and finish of panels and fabricated parts
- Symmetry, alignment and consistent spacing
- Overall attention to detail in the installation work
- Routing and organization of wiring, terminations and protection
- Quality and consistency of cable management (looms, sleeving, fastening, strain relief)
- Precision and quality of mounting and mechanical fixing
- Accessibility for service and maintenance where relevant
- Integration of components into the vehicle structure
- Quality of edges, joints and transitions between materials
- Attention to detail in visible and hidden areas
- Evidence of planning and professional execution

Scores should reflect the level of craftsmanship and effort demonstrated. Judges should use the full scoring range to reflect the quality and execution of the installation work.

Scoring guideline:

### Master Category

0 points – No effort beyond basic installation or OEM condition

1 point – Limited effort and basic execution

2 points – Clearly visible effort and good level of craftsmanship

Maximum 2 points per category (10 points total).

### Expert Categories

0 points – No effort made

1–3 points – Low effort and poor execution

4–6 points – Moderate effort and good execution

7–10 points – Clearly higher effort and excellent execution

Maximum 10 points per category (50 points total).

## Bonus points

Award bonus points for elements that belong to the installation and:

- Promote or highlight components used in the installation in an extraordinary way,
- Attract spectators (no noise accepted!!!),
- Where extra effort has been made to the installation to allow a normal use of the vehicle without sacrifice even though a system has been installed
- make a creative system presentation to the public

**NOTE:** Installations or modification to help improve the sound are not bonus points (as any improvements would be reflected in the scoresheet for sound).

The competitor must submit his requests for bonus points together with his presentation.

- Max 15 Points for Limited
- Max 100 Points for Unlimited

A maximum of 3 bonus points is available per request and scored as follows

- 1 for the idea itself
- 1 if average realization
- 2 if good realization



EMMA is powered by:

AI·SONIC

accuton®  
by Thiel & Partner

Art in Motion

Audiocircle

AudioControl®  
Making Good Sound Great™

audison

GERMAN CAR AUDIO  
3R-X

CONFUSE  
AUDIO

COMFORT  
SOUND DEADENING

CD  
AUDIO

CS CAR AUDIO  
SuperNaturalSound

Dragster  
AUDIO ART

EX CAR MEDIA SYSTEMS

FOCAL®

FOR-X

FOUR

GAS  
AUDIO POWER

GOLDHORN  
Your listening experience is our priority.

GERMAN  
MAESTRO

GLADEN®  
GERMAN TECHNOLOGY

GROUND ZERO®  
GERMAN ENGINEERING

HELIX  
GERMAN CAR HI-FI

HERTZ

HIFONICS  
POWER FROM THE GODS

JL AUDIO®  
Ahead of the Curve®

KICKER®  
PERFORMANCE AUDIO

MATCH  
BY AUDIOTEC FISCHER

morel

MOSCONI  
GLADEN AUDIO EUROPE

MUSWAY  
MUSIC IS THE WAY

PHOENIX GOLD

Pioneer

PARAMAT  
PCP  
SOUND DEADENING MANUFACTURERS

QUARTORIGO

Rebec  
CAR AUDIO

REISS AUDIO

RS  
Audio

SILENT®  
OAT

SounDigital

Stinger

STP STANDARTPLAST

VENOM®

VIBE  
BRITISH AUDIO

V<sup>2</sup> fibrofiltr